

GMG

FROM US TO YOU >

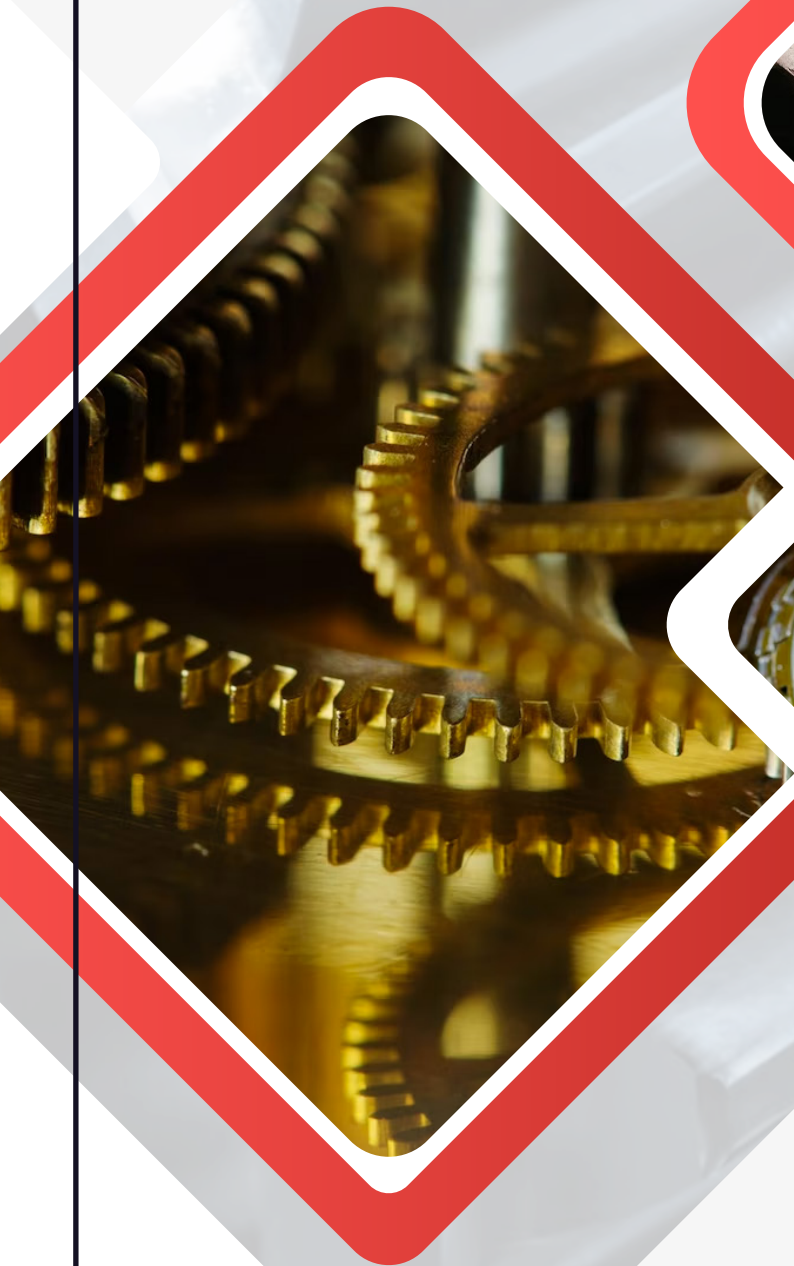

SOMMAIRE

PRESENTATION.....	P. 02
IDLERS & ROLLERS.....	P. 03
CONVEYOR BELT / V BELT / TIMER BELT.....	P. 04
MOTORS / GEAR BOX.....	P. 05
PARTS OF JAW & CONE.....	P. 06
WIRE MESH.....	P. 07
FILTRAGE.....	P. 08
AUTO PARTS.....	P. 09
CEMENT INDUSTRY'S PARTS.....	P. 11

PRESENTATION



We had just as idea in the mind but with hard work and dedication of the founders, we could turn this idea into reality. With extreme support of the staff, today we reached to a position where we are exporting our quality products to countries like USA, Italy, Africa, Gulf and middle east, Spain and many more.

GMG internatinal established in the year 2019 with the aim to provide best quality products to the customers. We strongly believe in our ethics and customer's satisfaction. Our highly qualified and experienced staff is added advantage to provide the best service to our customer and believing long term relationship.

GMG internatinal has achieved leadership in the market by providing best quality products, maintained delivery schedule, reasonable price and service after sales.

Our team is well trained and stands with dedication and respect to achieve customer satisfaction, with the use of their technical and commercial knowledge.

IDLERS & ROLLERS (ROULEAUX)



BEARINGS



CONVEYOR BELT / V BELT / TIMER BELT (CEINTURE)

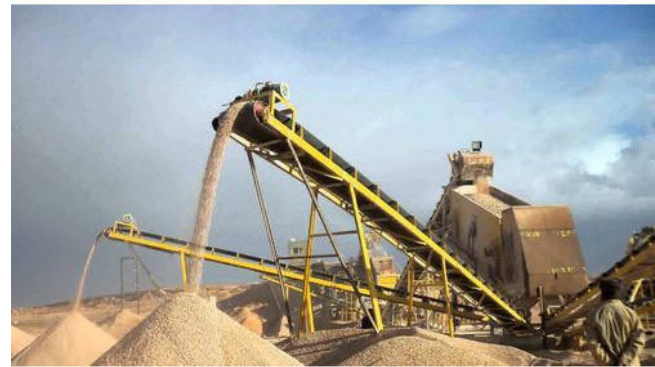

MOTORS (MOTEURS)



GEAR BOX (BOÎTE DE VITESSES)

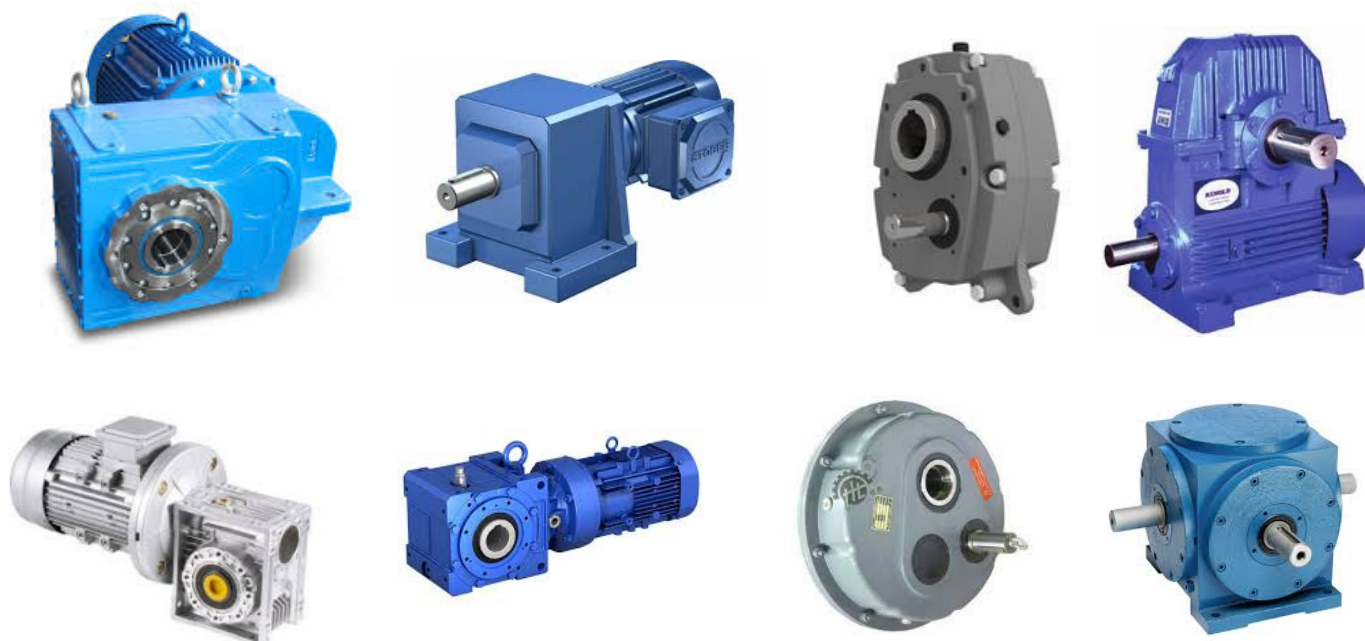

PARTS OF JAW & CONE

(PARTIES DE LA MÂCHOIRE ET DU CÔNE)

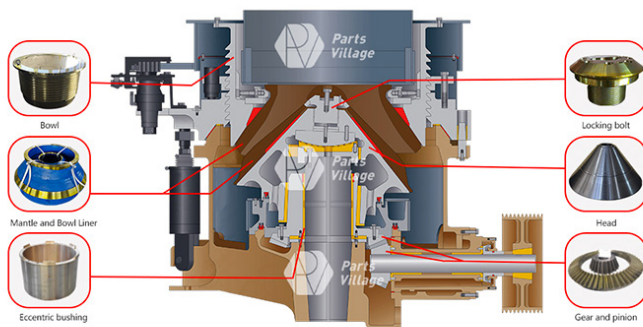
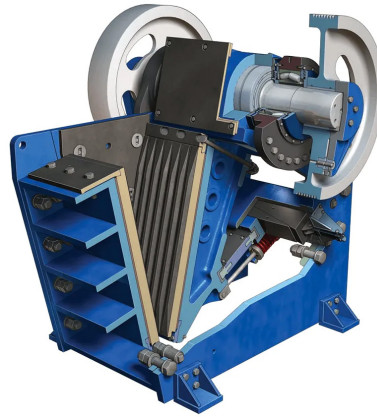

HP SERIES MULTI-CYLINDER CONE CRUSHER

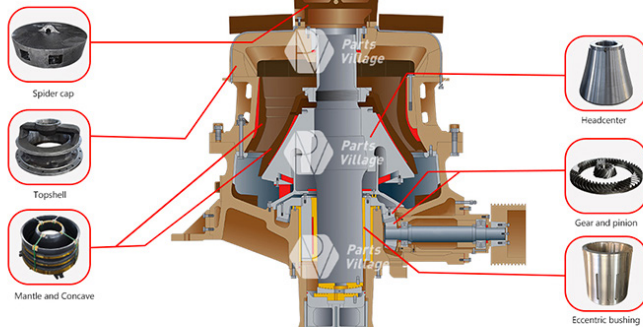

SINGLE-CYLINDER CONE CRUSHER



WIRE MESH (TREILLIS MÉTALLIQUE)

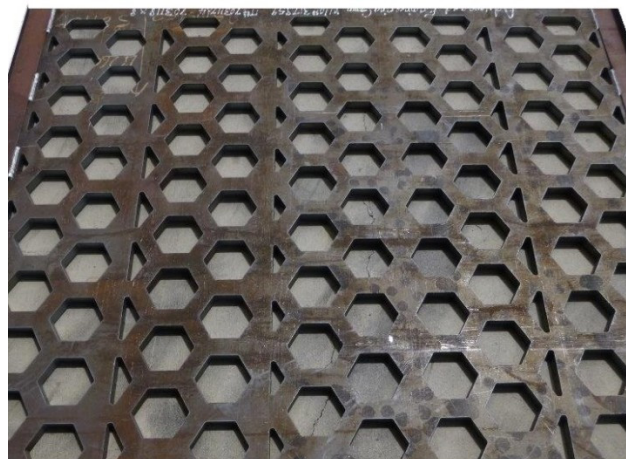
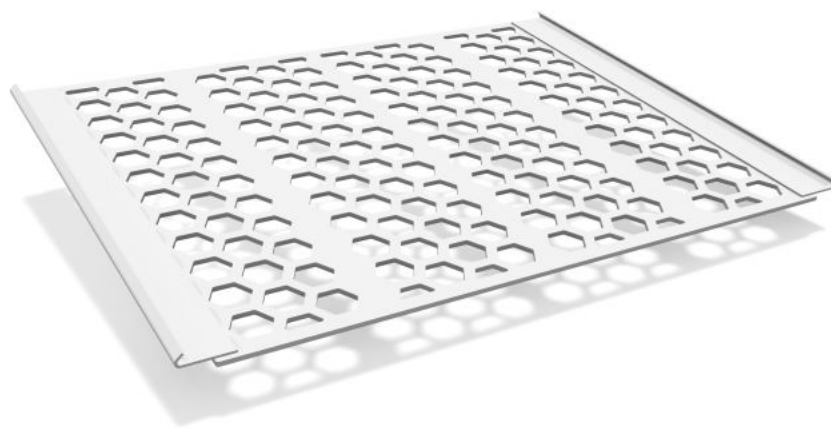
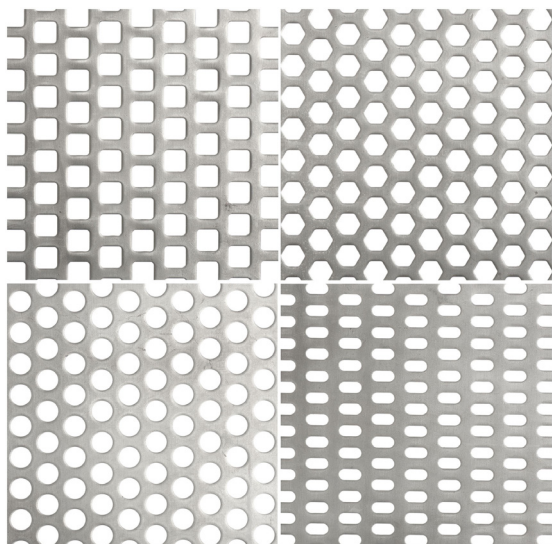

FILTRAGES (FILTRES)



AUTO PARTS (PIÈCES AUTOMOBILES)

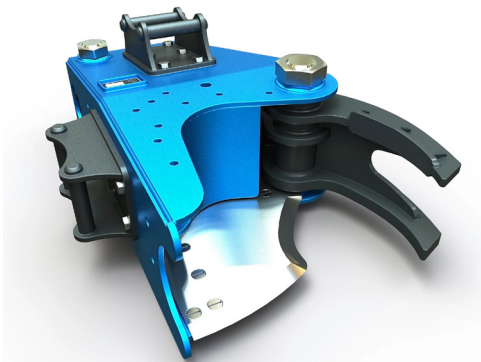

AUTO PARTS (PIÈCES AUTOMOBILES)

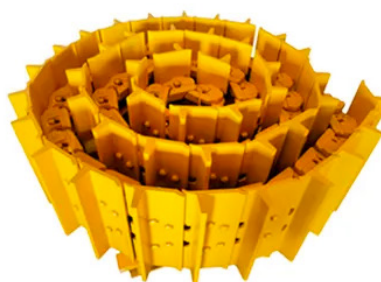
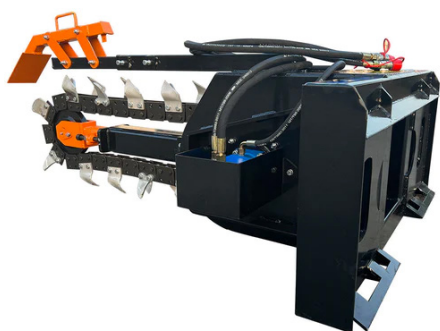

CEMENT INDUSTRY'S PARTS (PIÈCES DE L'INDUSTRIE DU CIMENT)

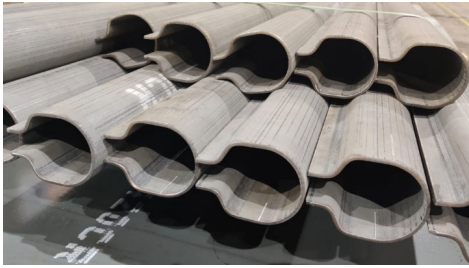
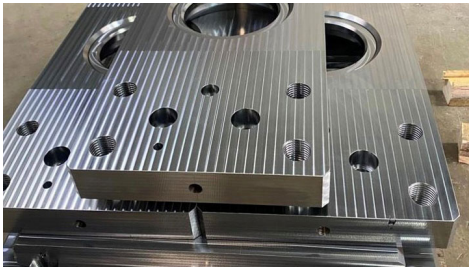
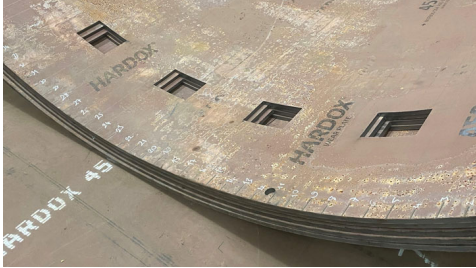

GTMG

FROM US TO YOU »

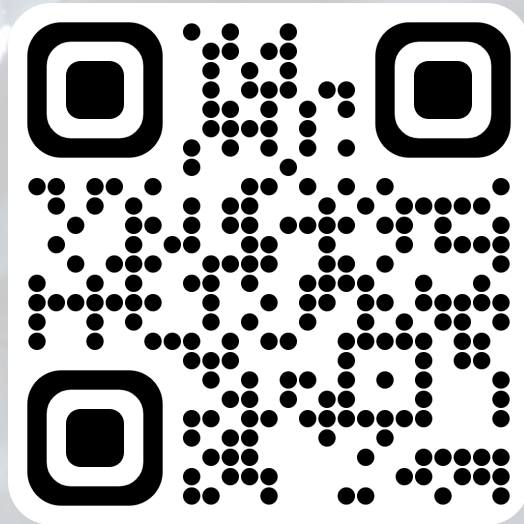

AVEC CE QR CODE RENDEZ VOUS
SUR NOTRE SITE WEB !

 82 rue Carvin France

 +33 6 58 96 27 87

 info@gmginternational.org